

ASI-3

Airspeed Indicator (ASI) with automatic flight log

Operating Manual – English 1.01



Introduction

The ASI-3 airspeed indicator is a 3 1/8" instrument that provides a wide range airspeed indication in both digital and analog formats. Airspeed is based on the pressure generated by a pitot tube system and a static port is provided as well for use by high speed aircraft. In addition, the ASI-3 provides a 24 entry automatic flight log that stores the duration of each of the last 24 flights, an air-distance trip counter and a current flight timer.

Airspeed can be indicated in statute miles per hour (mph), kilometers per hour (km/h) or nautical miles per hour (knots) with the air-distance being displayed in corresponding units. The analog airspeed display can be scaled according to the aircraft's flying speed range and markers for V_s , V_f , V_{no} and V_{ne} can be set. ASI sensitivity can be calibrated by the user to cater for errors caused by pitot tube placement.

The ASI-3 instrument measures airspeed from 16mph to 250mph and is well suited to slower aircraft due to very good sensitivity and linearity at low air speeds.

1 Features

- Measure airspeed from 16mph to 250mph and is well suited to slow aircraft due to very good sensitivity and linearity at low air speeds
- Includes a 24 entry automatic flight log
- Includes an air-distance trip counter and a flight timer
- Airspeed units can be set to miles per hour (mph), kilometer per hour (km/h) or nautical miles per hour (knots)
- Contains a programmable low/high airspeed alarm
- Records maximum airspeed reached in permanent memory
- Analog bar graph indicating airspeed with markers for V_s , V_f , V_{no} and V_{ne}
- Standard 3 1/8" aircraft enclosure (can be front or rear mounted)
- Rotary control plus 2 independent buttons for easy menu navigation and user input
- External alarm output as well as a red LED illuminates when the alarm has been activated
- Large backlit graphic LCD with adjustable contrast
- Wide input supply voltage range of 8 to 30V DC with built in voltage reversal and over voltage protection for harsh electrical environments
- Light weight design
- 1 year limited warranty

2 ASI-3 Layout

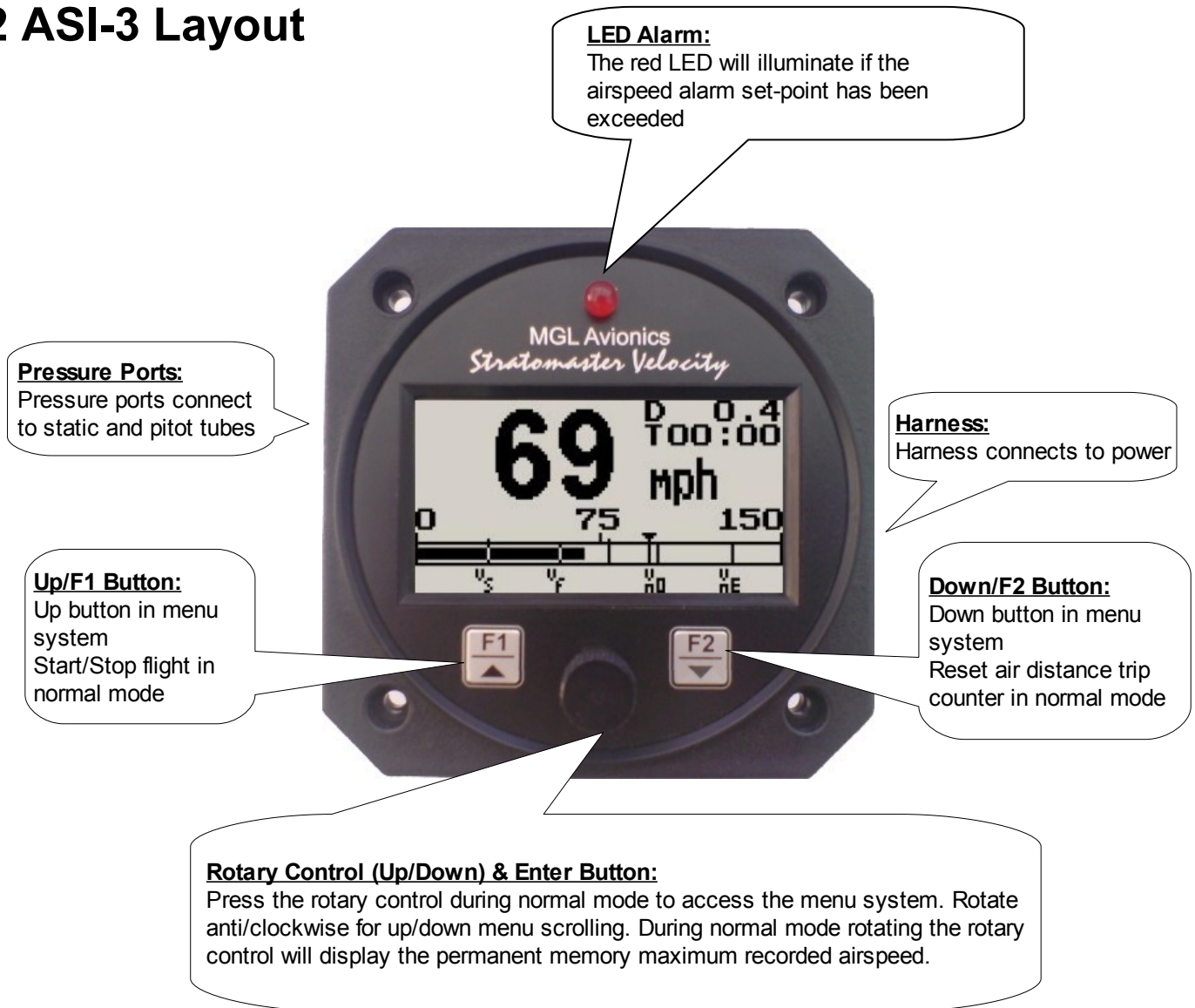

3 Main Display

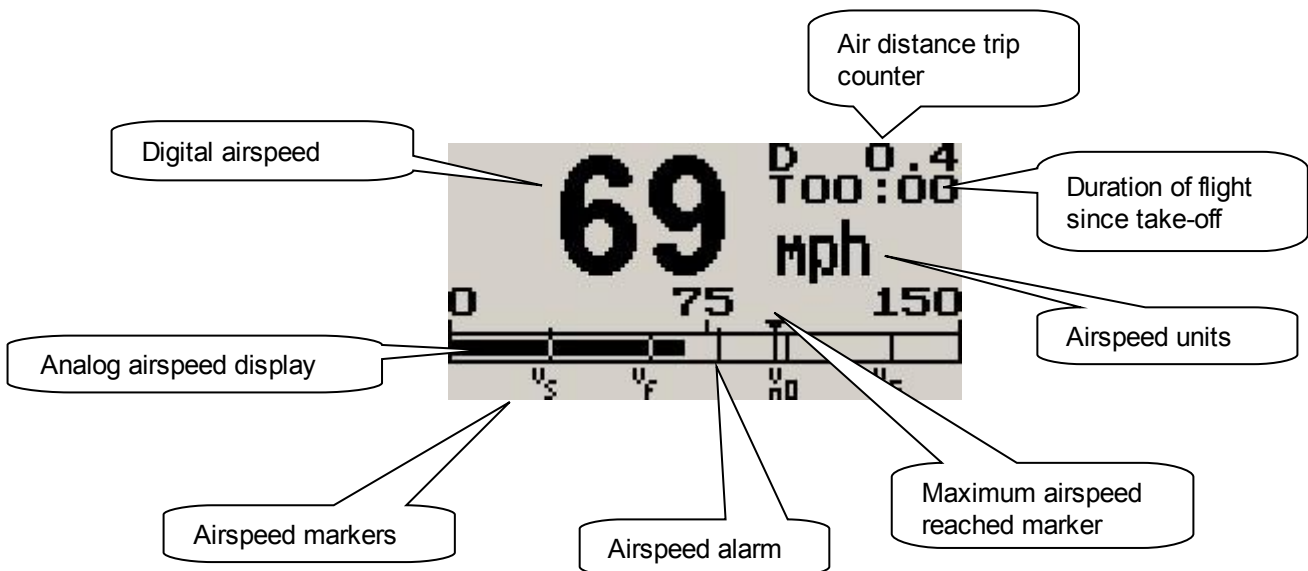

3.1 Start/Stop Flight Display



Press the F1 key during the normal display mode to manually start/stop a flight. This key is only active if the ASI-3 is setup to select the manual flight option under the “Flight Log” setup menu.

3.2 Reset Air Distance Trip Counter Display

This display can be accessed by pressing the F2 key during the normal display mode. Pressing the F1 key will reset the air distance trip counter to zero. Pressing any other key will cause the ASI-3 to resume to the normal display mode. The air distance trip counter can still be reset manually even if the pilot selects the automatic resetting of the air distance trip counter.

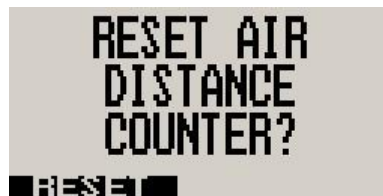

Note: The air distance trip counter measures distance flown through the air. This is not the same as distance flown over the ground unless you are flying at sea level at zero wind speed. The air distance shown is subject to under reading at altitude due to decreased air density.

3.3 Maximum Airspeed Display

This display can be accessed by rotating the rotary control either clockwise or anticlockwise during the normal display mode. Pressing the F1 key again will reset the maximum airspeed to the current airspeed. Pressing any other key will cause the ASI-3 to resume back to the normal display mode. To avoid false recordings, the maximum airspeed function is only activated 10 seconds after the instrument has powered up.



Note: The maximum airspeed is stored in non-volatile memory and is recalled on power-up.

4 Menu System

Pressing the rotary control button during the normal display mode will cause the ASI-3 to enter the menu system. Use the up/down keys or the rotary control to navigate through the menu system.

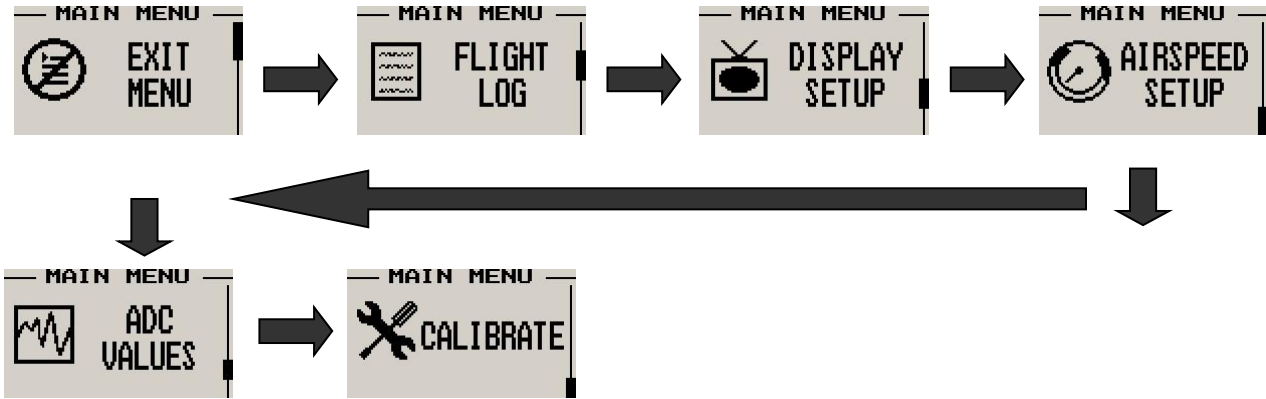

Note: (ADC Values and Calibrate Menus are only visible when powering up the unit and pressing the Rotary Control). The text "CALIBRATE" will appear on the intro screen when entering this mode.

Warning: The Calibrate Menu is for technical personnel only. Changing any values in this menu may cause the instrument to display incorrect information, and may require the instrument to be returned to the factory for recalibration.

4.1 Exit Menu



Pressing the rotary control on this menu item will cause the ASI-3 to exit the menu system. All changes made during navigation of the menu system will be saved in non-volatile memory on exiting the menu system. If you remove power before exiting the menu the instrument will not save any changes.

4.2 Flight Log



The ASI-3 uses the following algorithm to determine if a flight is in progress (Detect Mode): If airspeed is greater than the preset flight take off airspeed for a duration of 60 seconds or more, a flight is started with a logbook entry. The flight ends if airspeed falls below the preset flight take-off airspeed for 30 seconds. During a flight the logbook cannot be viewed.

The above algorithm ensures that touch-and-goes will not result in the end of a flight and a logbook entry. Should the instrument be switched off during a flight, this will end the flight and the log will reflect the time until the instrument was switched off. Should the instrument be switched on again during a flight, a new flight will start for logging purposes.



Move the highlight over the "DONE" menu item and press the rotary button to return to the main menu



Select this function to view the flight log. The flight log contains the duration of each of the last 24 logged flights. Duration is displayed in hours and minutes. Eight flights are displayed at a time, use the up/down keys or the rotary control to navigate through the log. Empty log entries are shown as "----".

Note: You cannot select this function while a flight is in progress.



Pressing the F1 key will erase all the flight log entries



Select if you would like the hour to be displayed in decimal fractions (0-99) or minutes (0-59). This setting influences the current flight time display and the flight log.



Select whether you want the ASI-3 to automatically detect a flight or whether the pilot must press the F1 key to start/stop a flight.



This menu option is only shown if the "detect" flight mode is selected. Enter the airspeed that you want to start a flight log.

4.3 Display Setup



Move the highlight over the "DONE" menu item and press the rotary button to return to the main menu



Select this menu option to adjust the display contrast



Select this menu option to turn the backlight on or off

4.4 Airspeed Setup



All the airspeed parameters can be setup here

```

-- ASI SETUP --
*** DONE ***
ZERO ASI SENSOR
ASI SPAN: 150
LOW ALARM: ON
LOW ALARM: 30
HIGH ALARM: ON
HIGH ALARM: 80
    
```

Move the highlight over this menu option and press the rotary button to return to the main menu

```

-- ASI SETUP --
*** DONE ***
ZERO ASI SENSOR
ASI SPAN: 150
LOW ALARM: ON
LOW ALARM: 30
HIGH ALARM: ON
HIGH ALARM: 80
    
```

```

ARE YOU SURE
YOU WANT TO
ZERO THE AIR
SPEED SENSOR?
ZERO
    
```

This setup allows your instrument to measure the zero airspeed reading of the airspeed sensor and set a calibration value internally for this. This is equivalent to some mechanical airspeed indicators that have an adjustment to set the needle to zero when the aircraft is not moving. You would use this function occasionally if you see an airspeed reading when the aircraft is at rest. This may be caused by aging of the built in pressure sensor or related electronics. When this function is performed make sure that there is no air flow into the pitot tube as this would result in an incorrect internal calibration.

Pressing the F1 key will zero the airspeed sensor.

```

-- ASI SETUP --
*** DONE ***
ZERO ASI SENSOR
ASI SPAN: 150
LOW ALARM: ON
LOW ALARM: 30
HIGH ALARM: ON
HIGH ALARM: 80
    
```

Select the maximum value that you want the airspeed analog bar graph display to show. This can give you increased display resolution.

```

-- ASI SETUP --
*** DONE ***
ZERO ASI SENSOR
ASI SPAN: 150
LOW ALARM: ON
LOW ALARM: 30
HIGH ALARM: ON
HIGH ALARM: 80
    
```

Select whether you want the low air speed alarm to be turned on or off. The low airspeed alarm is only activated once a flight has started.

```

-- ASI SETUP --
*** DONE ***
ZERO ASI SENSOR
ASI SPAN: 150
LOW ALARM: ON
LOW ALARM: 30
HIGH ALARM: ON
HIGH ALARM: 80
    
```

Enter the low airspeed set-point for when the alarm must activate. Any speed below this value will activate the alarm.

```

-- ASI SETUP --
*** DONE ***
ZERO ASI SENSOR
ASI SPAN: 150
LOW ALARM: ON
LOW ALARM: 30
HIGH ALARM: ON
HIGH ALARM: 80
    
```

Select whether you want the high air speed alarm to be turned on or off.

```

-- ASI SETUP --
*** DONE ***
ZERO ASI SENSOR
ASI SPAN: 150
LOW ALARM: ON
LOW ALARM: 30
HIGH ALARM: ON
HIGH ALARM: 80
    
```

Enter the high airspeed set-point for when the alarm must activate. Any speed above this value will activate the alarm.

```

-- ASI SETUP --
ZERO ASI SENSOR
ASI SPAN: 150
LOW ALARM: ON
LOW ALARM: 30
HIGH ALARM: ON
HIGH ALARM: 80
ASI UNIT: MPH
    
```

Select your preferred units. You can select statute miles, kilometers or nautical miles. According to this selection your airspeed will be indicated in mph, km/h or knots.

```

-- ASI SETUP --
ASI SPAN: 150
LOW ALARM: ON
LOW ALARM: 30
HIGH ALARM: ON
HIGH ALARM: 80
ASI UNIT: MPH
ASI FILTER: FAST
    
```

This function can be used to select the signal filter time constant. Selections are "fast" or "slow". This selection influences the rate at which your ASI can change its reading. If you have an installation that suffers from strong turbulence at the pitot tube, select "slow". If you have a very clean airflow in front of the pilot tube you can select "fast" which will give you a faster response to airspeed changes.

```

-- ASI SETUP --
LOW ALARM: ON
LOW ALARM: 30
HIGH ALARM: ON
HIGH ALARM: 80
ASI UNIT: MPH
ASI FILTER: FAST
DIST ZERO: MAN
VS SPEED: 30
    
```

Select if you want the air-distance counter to reset automatically at the start of a flight or if you want to reset manually only.

Note: You can reset the air distance counter at any time regardless of this setting.

```

-- ASI SETUP --
LOW ALARM: 30
HIGH ALARM: ON
HIGH ALARM: 80
ASI UNIT: MPH
ASI FILTER: FAST
DIST ZERO: MAN
VS SPEED: 30
    
```

You can set up a marker on the analog airspeed display for Vs. Vs would be your stall speed or minimum safe flying speed. You may also choose to use this marker as your approach speed.

```

ASI SETUP
HIGH ALARM: ON
HIGH ALARM: 80
ASI UNIT: mph
ASI FILTER: FAST
DIST ZERO: MAN
US SPEED: 30
VF SPEED: 60
    
```

You can set up a marker on the analog airspeed display for Vf. Vf is your maximum flap speed.

```

ASI SETUP
HIGH ALARM: 80
ASI UNIT: mph
ASI FILTER: FAST
DIST ZERO: MAN
US SPEED: 30
VF SPEED: 60
VNO SPEED: 100
    
```

You can set up a marker on the analog airspeed display for Vno. Vno is the maximum maneuvering speed or top end of the normal operating speed range.

```

ASI SETUP
ASI UNIT: mph
ASI FILTER: FAST
DIST ZERO: MAN
US SPEED: 30
VF SPEED: 60
VNO SPEED: 100
VNE SPEED: 160
    
```

You can set up a marker on the analog airspeed display for Vne. Vne is the never exceed maximum speed.

4.5 ADC Values

```

MAIN MENU
[Waveform Icon] ADC
VALUES
    
```

Note: This menu item is for technical personnel only, and is not displayed during the normal operation of the instrument. Please see section 4 above on how to access this menu item.

```

ADC VALUES
*** DONE ***
AIRSPEED: 322
    
```

This menu displays the ADC values that have been read from the pressure sensor.

4.6 Calibrate

```

MAIN MENU
[Wrench Icon] CALIBRATE
    
```

Note: This menu item is for technical personnel only, and is not displayed during the normal operation of the instrument. Please see section 4 above on how to access this menu item. Consult your local dealer or factory before entering this menu.

```

CALIBRATE
*** DONE ***
CAL: +100% 69
    
```

This function is used to calibrate your airspeed indicator. During the factory calibration a factor has been determined and entered here that will give you accurate airspeed, provided your pitot tube is not influenced by pressure effects caused by airflow around your airframe. The calibration is displayed in % of the reading, you can increase or decrease the reading if required to help cancel out under or over reading of the airspeed indicator on your aircraft. The original calibration factor has been written onto the back of your instrument.

5 Loading Factory default settings

Pressing and holding the F1 and F2 key simultaneously on power up will cause the ASI-3 to load preprogrammed factory default settings. The following screen will be displayed:

```

LOADING
DEFAULT
SETTINGS
    
```

6 Operating the alarms

If the alarm is activated, the corresponding item on the display will flash. At the same time the externally available alarm switch will close. The switch will remain closed until any button is pressed to acknowledge the alarm or until the condition(s) that activated the alarm no longer exist. The alarm output can be used to switch an external alarm indicator. The external alarm switch is an open collector transistor switch to ground with a maximum rating of 0.5A DC. It is possible to wire the alarm contacts of several Stratomaster instruments in parallel should this be desired. To avoid false activation of the alarms, the alarm function is only active 10 seconds after the instrument has powered up.

7 Cleaning

The unit should not be cleaned with any abrasive substances. The screen is very sensitive to certain cleaning materials and should only be cleaned using a clean, damp cloth.

Warning: The ASI-3 is not waterproof, serious damage could occur if the unit is exposed to water and/or spray jets.

8 Specifications

Operating Temperature Range	-10°C to 50°C (14°F to 122°F)
Storage Temperature Range	-20°C to 80°C (-4°F to 176°F)
Humidity	<85% non-condensing
Power Supply	8 to 30Vdc SMPS (switch mode power supply) with built in 33V over voltage and reverse voltage protection
Current Consumption	Approx. 44mA @ 13.8V (backlight on) 16mA @13.8V (backlight off)
Display	128x64 graphic LCD display. Contrast and backlight is user configurable, green/yellow backlight
ADC	12bit over sampled successive approximation
Dimensions	see Velocity series dimensional drawing
Enclosure	3 1/8" ABS, black in color, front or rear mounting
Weight	Approx. 176 grams
Alarm contact current rating	Open collector transistor switch to ground. Maximum rating 0.5A DC
Non-volatile memory storage	100000 write cycles
Airspeed range	16mph to 250mph
Airspeed resolution	1 mph
Measurement accuracy	+/-1% at 85mph nominal

9 Installation

Connect a pitot tube to the "pressure port" and if required connect the static port. Pitot tubes are found in a large variety at your aircraft parts shop, in mail order catalogs or you can make your own. Contrary to popular belief, pitot tubes are not carefully designed and calibrated but are simple orifices or tubes that get pointed in the direction that you are flying. The forward movement of the aircraft causes air to dam inside the pitot tube. This increases the pressure inside the tube. Most small aircraft such as ultralights or microlights do not require a connection to a static port. In these cases, simply leave the static port open. Ensure however that the static port does not receive pressurized air due to the forward movement of the aircraft. Be especially critical of your pod or panel if you do not use a static port. Any build up of a pressure differential due to ram air or suction can lead to large errors of the indicated airspeed. Static ports are usually mounted at a strategic position on the rear side of the aircraft fuselage for faster, pressurized aircraft. Suitable pitot tubes can be made from a short piece of hollow aluminum or copper piping. Length and diameter are not important. Ensure that the front of the pitot tube has a suitable chamfer if you use thick walled tubing or you may introduce a speed reading error if you have a faster aircraft.

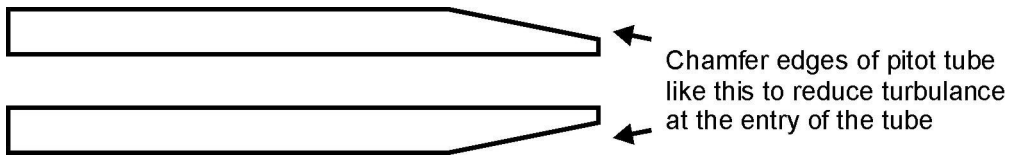

Example cross-section of thick walled pitot tube.

Suitable connection hose for both pitot tube and static port can be obtained from a hardware store or even a pet shop. Good quality tubing is often used for fish tanks and it has just the right diameter.

Please note that this kind of tubing is not advised for pressurized aircraft. In this case you would need to obtain aircraft grade tubing of suitable diameter. You would also have to use hose clamps to fasten the hose onto the ASI-3 pitot and static ports. The ASI-3 allows you to calibrate the airspeed reading. This is done under the "Calibrate" menu item. The main reason for this is to be able to remove errors introduced due to the airflow around your aircraft which may have an effect on your pitot tube pressure.

9.1 Connection Diagram

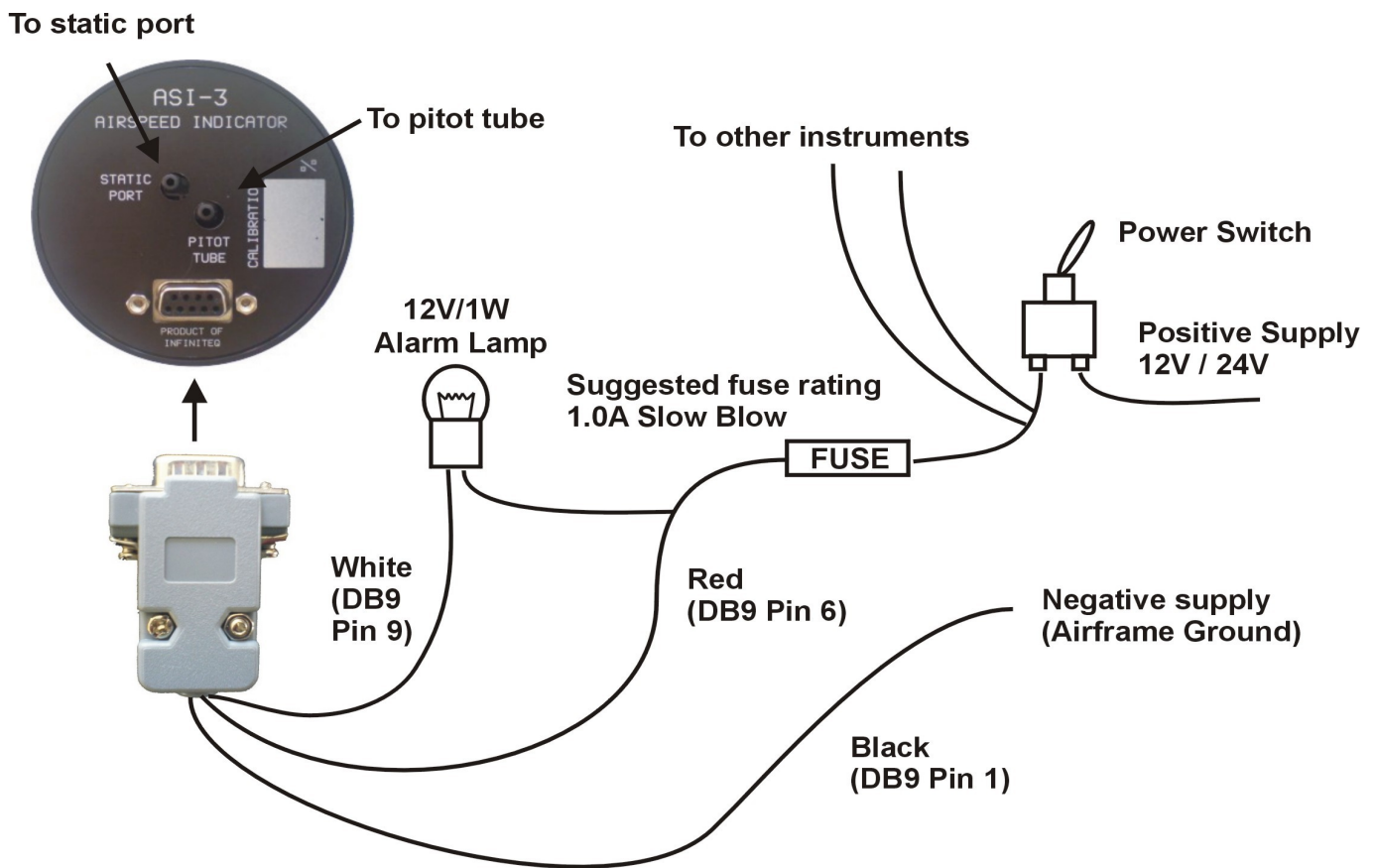

The use of an external 1A fuse is recommended. Connect the supply terminals to your aircrafts power supply. The ASI-3 can be used on both 12V and 24V without the use of any pre-regulators. Ensure that the supply voltage will not drop below 8V during operation as this may result in incorrect voltage and or current readings.

9.2 ASI-3 DB9 Cable connections

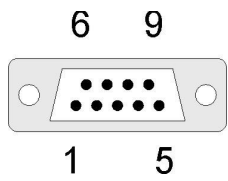

DB 9 Pin	Color	Function
1	Black	Ground
4	NC	Airtalk communication (Not connected) Used for firmware upgrading
6	Red	8-30Vdc power
9	White	Alarm Output

9.3 Pressure Port Dimensions

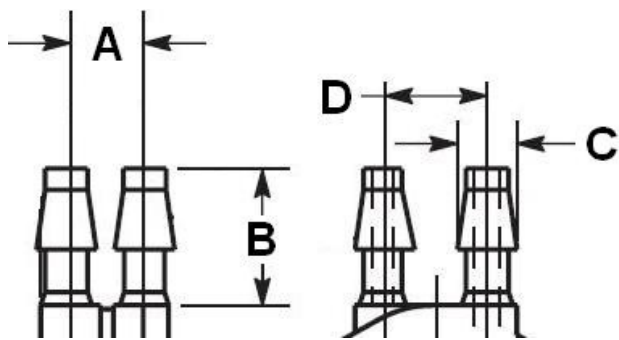

	Inches		Millimeters	
	Min	Max	Min	Max
A	0.248	0.278	6.30	7.06
B	0.420	0.440	10.67	11.18
C	0.182	0.194	4.62	4.93
D	0.310	0.330	7.87	8.38

10 Warranty

This product carries a warranty for a period of one year from date of purchase against faulty workmanship or defective materials, provided there is no evidence that the unit has been mishandled or misused. Warranty is limited to the replacement of faulty components and includes the cost of labor. Shipping costs are for the account of the purchaser.

Damage as a result of applying excessive pressure to the pressure ports are excluded from warranty.

Note: Product warranty excludes damages caused by unprotected, unsuitable or incorrectly wired electrical supplies and/or sensors, and damage caused by inductive loads.

11 Disclaimer

Operation of this instrument is the sole responsibility of the purchaser of the unit. The user must make themselves familiar with the operation of this instrument and the effect of any possible failure or malfunction.

This instrument is not certified by the FAA. Fitting of this instrument to certified aircraft is subject to the rules and conditions pertaining to such in your country. Please check with your local aviation authorities if in doubt. This instrument is intended for ultralight, microlight, homebuilt and experimental aircraft. Operation of this instrument is the sole responsibility of the pilot in command (PIC) of the aircraft. This person must be proficient and carry a valid and relevant pilot's license. This person has to make themselves familiar with the operation of this instrument and the effect of any possible failure or malfunction. Under no circumstances does the manufacturer condone usage of this instrument for IFR flights.

The manufacturer reserves the right to alter any specification without notice.

Other instruments in the *Stratomaster Velocity* series

ALT-3	Encoding aviation altimeter and Vertical speed indicator (VSI)
ALT-4	Encoding aviation altimeter with Serial RS232 & Parallel Gillham code output
ASI-3	Airspeed indicator (ASI) with automatic flight log
ASX-2	Encoding aviation altimeter and Airspeed indicator (ASI)
AV-2	Artificial horizon and magnetic compass indicator
E-1	Universal engine monitor
FLIGHT-2	Primary Flight instrument
FF-3	Fuel Computer (single or dual fuel tanks)
GF-2	+/-10G tilt compensated dual range G-force meter
MAP-2	Manifold pressure and RPM Indicator
ROTOR-1	Dual Rotor / Engine tachometer
RTC-1	Aviation real time clock (RTC), outside air temperature (OAT) and Voltage display
RV-3	Universal engine / Rotor RPM Indicator
TC-2	4-Channel thermocouple (EGT/CHT) indicator
TC-3	12-Channel thermocouple (EGT/CHT) indicator
TP-2	Universal temperature and pressure gauge