

ALT-3

Precision Aviation altimeter and Vertical speed indicator

Operating Manual – English 1.01



Introduction

The ALT-3 is a 3 1/8" instrument that contains a precision altimeter and a wide range vertical speed indicator. The altimeter conforms to ANSI standard atmosphere rules from -1000 ft up to a maximum of 30 000 ft. The altimeter can display altitude in feet or meters, local pressure can be set in millibars or inches of mercury

The onboard VSI indicator is altitude compensated and can be displayed in either feet/minute (ft/min) or meters/second (m/s). It also offers a digital readout with a wide range from +/-20 ft/min to as high as +/-10 000 ft/min, it also offers a logarithmic analog display with a +/-2000 ft range. The VSI can be calibrated by the user once the instrument has been installed in the aircraft.

In addition the ALT-3 provides an OAT sender which is used in determining the density altitude of the aircraft. The ALT-3 can also be used to measure relative altitude and it has a facility for the pilot to enter a reference altitude and deviation band that has to be kept.

1 Features

- Precision altimeter from -1000 ft up to a maximum of 30 000 ft (-304m to 9144m)
- The altimeter can display altitude in feet or meters, local pressure can be set in millibars or inches of mercury
- Contains a wide range VSI indicator from +/-20 ft/min to as high as +/-10 000 ft/min
- VSI units can be in feet/minute (ft/min) or in meters/second (m/s)
- Records the maximum and minimum OAT (outside air temperature) and maximum altitude reached in permanent memory
- Records maximum and minimum OAT in temporary memory since instrument power up
- Standard 3 1/8" aircraft enclosure (can be front or rear mounted)
- Rotary control plus 2 independent buttons for easy menu navigation and user input
- Alarm output as well as a red LED illuminates when the alarm has been activated
- Large backlit graphic LCD with adjustable contrast
- Wide input supply voltage range of 8 to 30V DC with built in voltage reversal and over voltage protection for harsh electrical environments
- Light weight design
- Field upgradeable firmware
- 1 year limited warranty

2 ALT-3 Layout

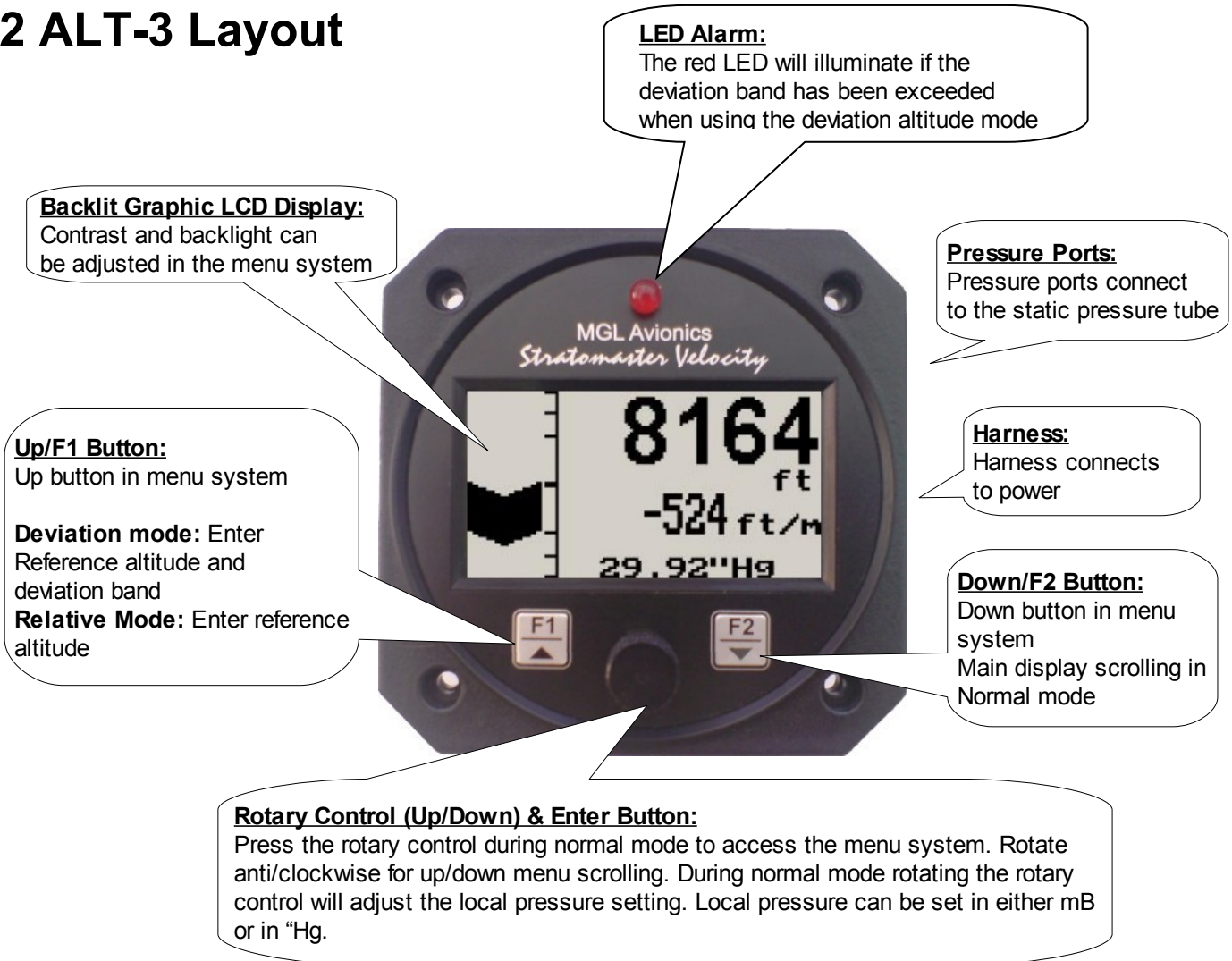

3 Main Display

The main displays can be toggled by pressing the F2/Down key.

3.1 Altitude and VSI display

This is the standard display for the ALT-3. Use the rotary control to adjust the local pressure setting.

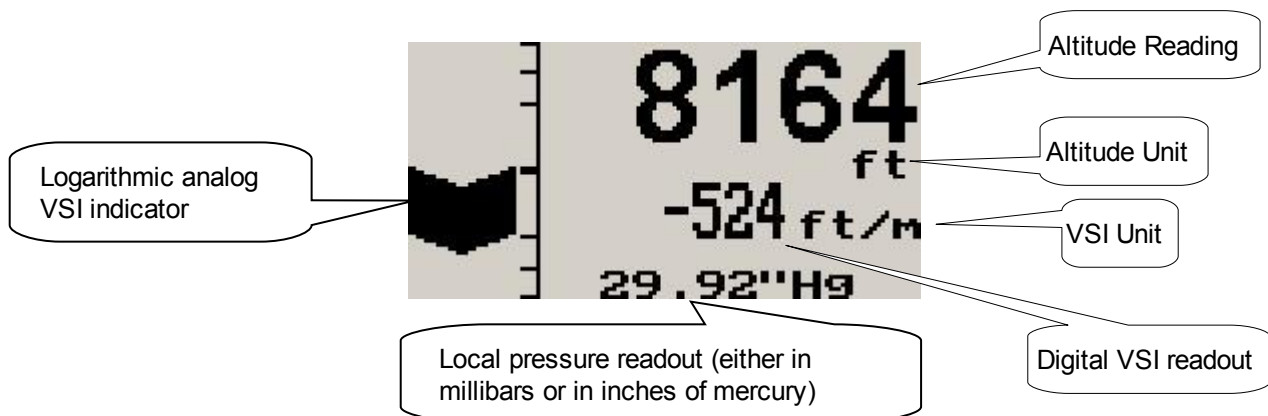

3.2 Altitude relative to sea level display

Use the rotary control to adjust the local pressure setting.

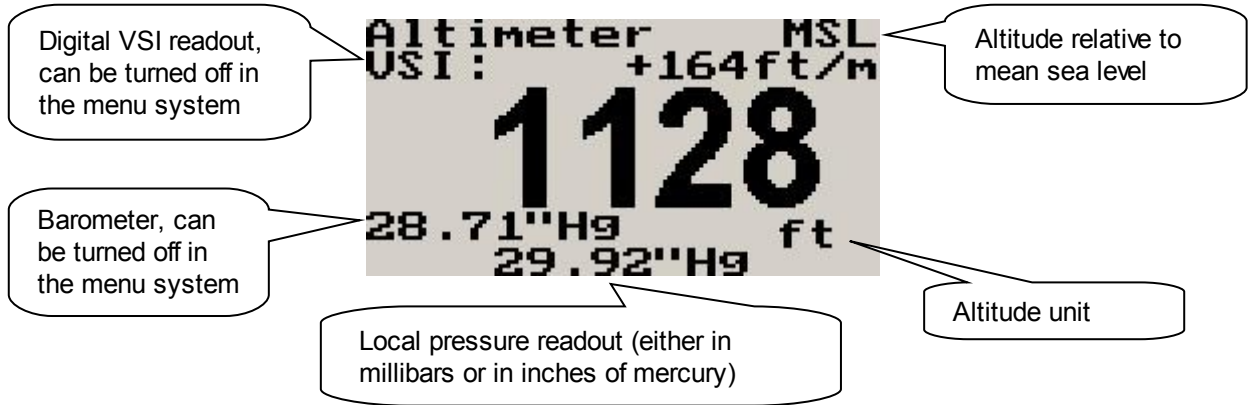

3.3 VSI (Vertical Speed Indicator)

The ALT-3 can be setup to be as a VSI (vertical speed indicator).



3.4 Deviation Altitude display

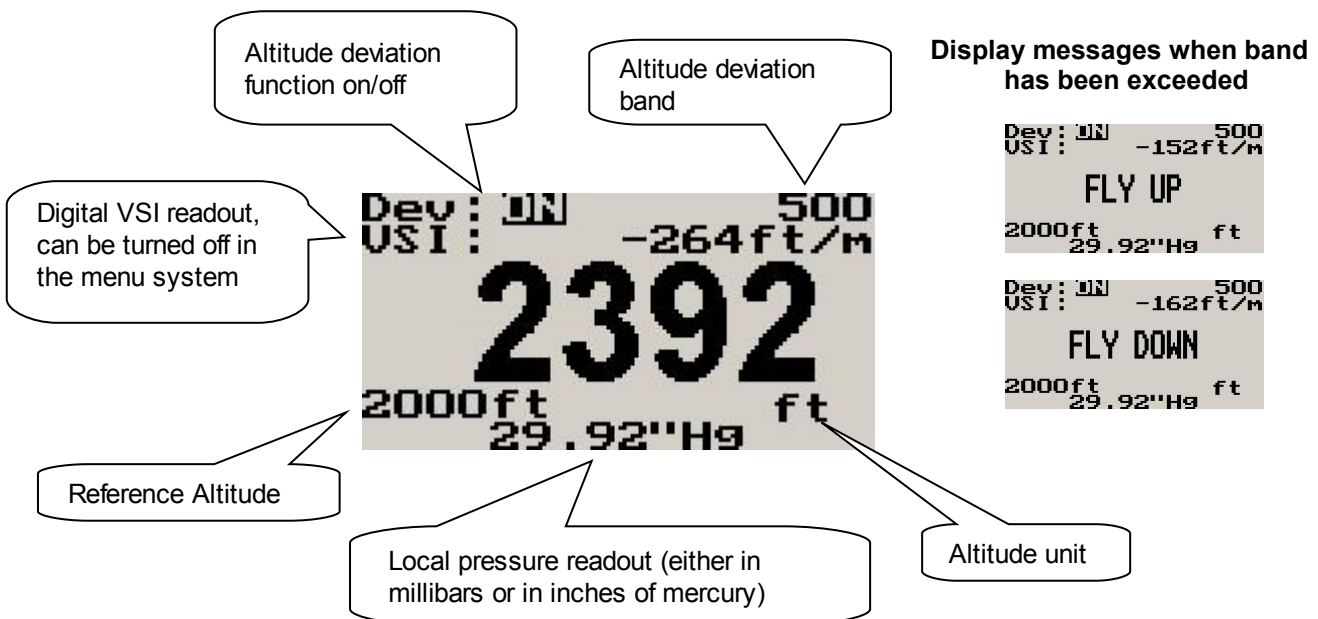

Use the rotary control to adjust the local pressure setting. Pressing the F1/up key will allow the pilot to enter a reference altitude and the deviation band.



Adjust the reference altitude using the rotary control. This is the altitude that the pilot wants to maintain. Press the F1 key to accept, press the F2 key to return to the main display.



Adjust the deviation band above and below your reference altitude that is still acceptable to fly in. Any altitude outside this band will activate the alarm. Press the F1 key to accept, press the F2 button to return to the main display.



Select whether you want the altitude deviation feature enabled or not. Press the F1 key to enable the altitude deviation feature, press the F2 key to disable the altitude deviation feature.

3.5 Relative Altitude display

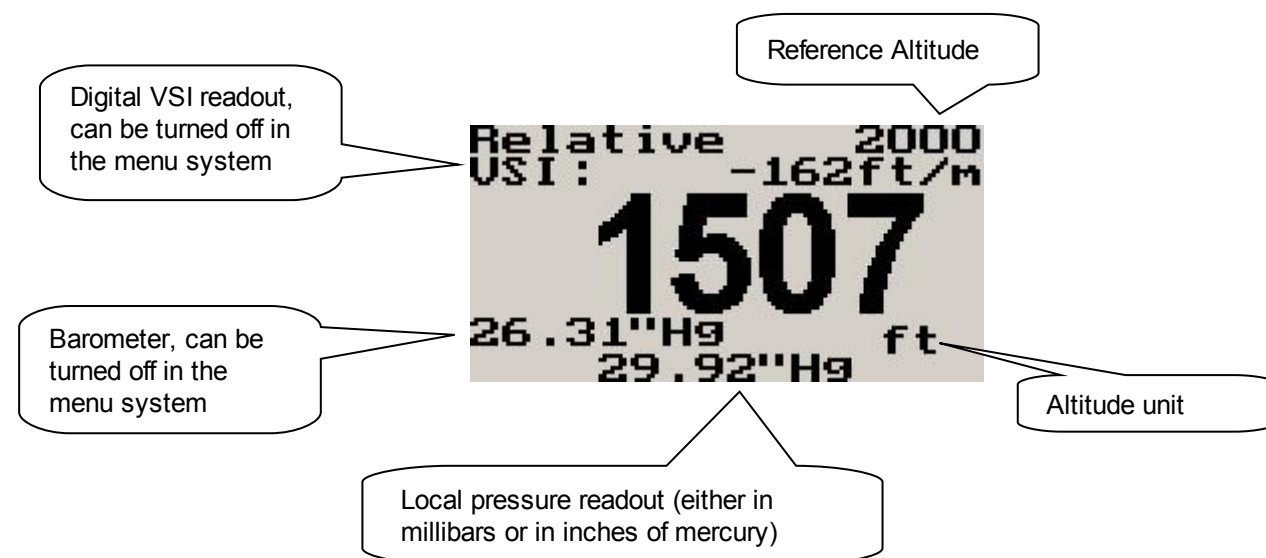

Use the rotary control to adjust the local pressure setting. Pressing the F1/up key will allow the pilot to enter a reference altitude.



Enter the reference altitude you would like to use in relative mode. Use the rotary control to adjust the reference altitude. Press the F1/up key to accept.

3.6 Density Altitude display

Density altitude is a perceived altitude that pertains to your current altitude and temperature (and to a lesser extent on your current moisture content of the air). Density altitude is relevant for performance calculations of your aircraft. Density altitude affects the performance of your engine, propeller and airfoils. The most noticeable affects of density altitude are length of take-off and landing runs and the ability of your aircraft to carry weight. There are several methods to calculate density altitude, all result in readings that are very close to each other. We decided to implement a popular formula that is often used by pilots to calculate density altitude at their location.

Da = Density altitude
 Pa = Pressure altitude
 T = ambient temperature in degrees C
 $T_s = 15 - 0.0019812 * \text{pressure altitude (ft)}$

$$Da = Pa + 118.6 * (T - T_s)$$

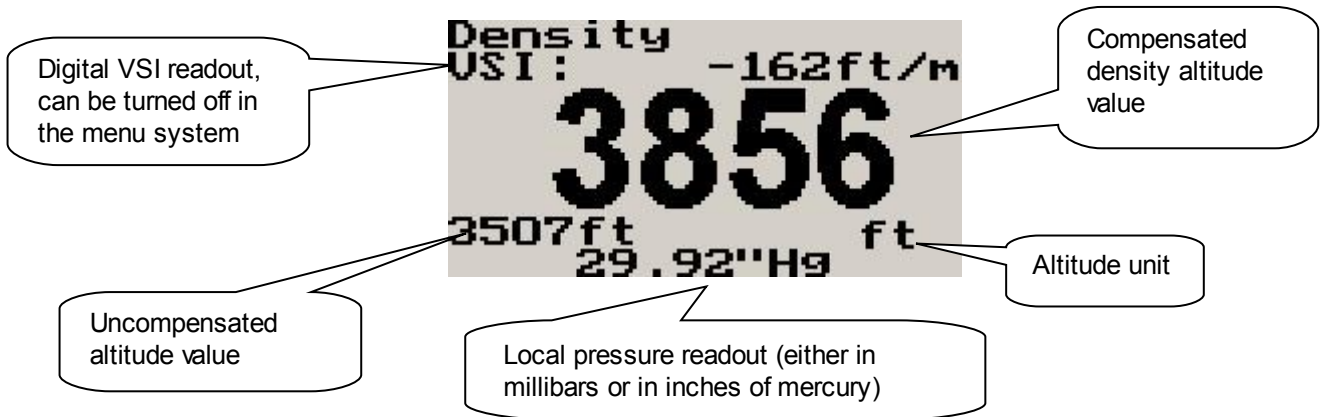

3.7 OAT (Outside air temperature) Display

The OAT probe is used to determine density altitude. Press the F1 key to reset the min/max reading to the current reading.



4 Menu System

Pressing the rotary control button during the normal display mode will cause the ALT-3 to enter the menu system. Use the up/down keys or the rotary control to navigate through the menu system.

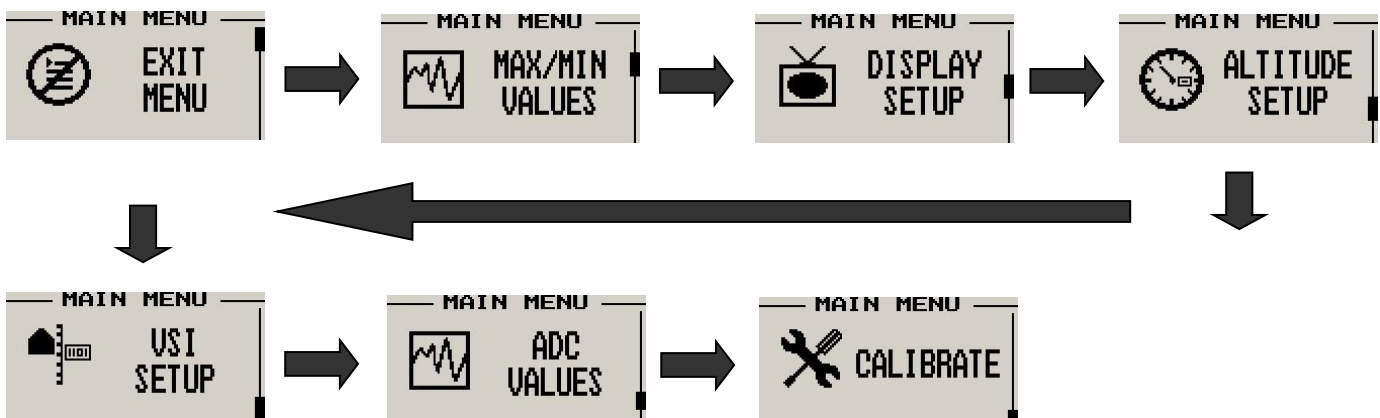

Note: (ADC Values and Calibrate Menus are only visible when powering up the unit and pressing the Rotary Control). The text "CALIBRATE" will appear on the intro screen when entering this mode.

Warning: The Calibrate Menu is for technical personnel only. Changing any values in this menu may cause the instrument to display incorrect information, and may require the instrument to be returned to the factory for recalibration.

4.1 Exit Menu



Press the rotary control on this menu item to exit the menu system. All changes made during navigation of the menu system will be saved in non-volatile memory on exiting the menu system. If you remove power before exiting the menu the instrument will not save any changes.

4.2 Maximum Values



To avoid false recordings, the maximum values function is only activated 10 seconds after the instrument has powered up.



Move the highlight over the "DONE" menu item and press the rotary button to return to the main menu.



Move the highlight over this menu item and press the rotary button to reset the maximum altitude and OAT values to the current values.

4.3 Display Setup



Move the highlight over this menu option and press the rotary button to return to the main menu.

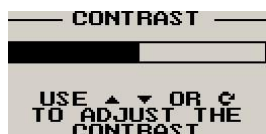

Select this menu option to adjust the display contrast.



Select this menu option to turn the backlight on or off.



Select whether you want the OAT to be displayed in degrees Fahrenheit (°F) or in degrees Celsius (°C).

4.4 Altitude Setup



All altitude related parameters can be setup here.

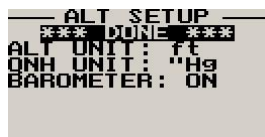

Move the highlight over the "DONE" menu item and press the rotary button to return to the main menu.

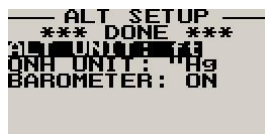

Select if you want your altitude readout in feet (ft) or meters (m).

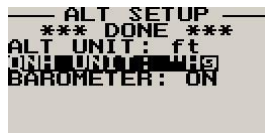

Select if you want your local pressure readout in millibars (mB) or inches of mercury ("Hg).

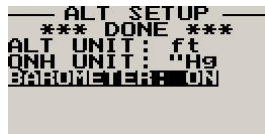

Select if you want the barometer to be displayed on the altitude screens or not.

4.5 VSI (Vertical Speed Indicator) Setup



All VSI related parameters can be setup here.



Move the highlight over the "DONE" menu item and press the rotary button to return to the main menu.

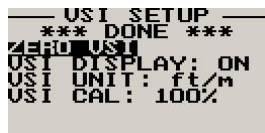

This function is used to set your VSI to read exactly 0ft/min. This is similar to setting the needle on a mechanical VSI to point to zero by turning the adjustment knob on such a VSI. The electronic VSI generally has much less drift compared to a mechanical VSI and this function will only be used very occasionally. Ensure that you perform this function when no pressure changes due to wind or other reasons are occurring.



Select if you want to show the built in VSI (vertical speed indicator). The built in VSI will be shown above the altitude readout.



Select if you want your VSI readout in feet/minute (ft/m) or meters/second (m/s). **Note:** meters/second will be shown with two decimals, example: "1.23".



This is a function that is used to calibrate your VSI to read exact rates of climb or decent. This function works as a percentage of initial reading. The default setting for this function is 100%. Increasing this value increases the VSI reading and decreasing the value decreases the reading.

Suggested VSI calibration method

After you have installed the instrument, perform a calibration flight. This should be done in very calm conditions. Turbulence and thermal activity will make accurate calibration impossible. Many areas have ideal conditions during early mornings or late afternoons. Place the instrument in “feet” unit mode for ease of calibration. Take your aircraft to a few thousand feet above ground and start a glide with a low power setting. Take a stopwatch and when the glide is stable (stable VSI reading) start the stopwatch. Take note of your altimeter reading at the same time. Continue the stable glide for one minute exactly. After the minute has finished, take another reading of your altimeter.

Example:

VSI reading during stable glide: -400 ft/min

Start altitude: 2500 ft.

End altitude: 2050 ft.

In the above example the VSI is under reading by about 12%. Set your VSI calibration to 112% to cancel out the error.

4.6 ADC Values



Note: This menu item is for technical personnel only, and is not displayed during the normal operation of the instrument. Please see section 4 above on how to access this menu item.



This menu displays the ADC values that have been read from the pressure sensors.

4.7 Calibrate



Note: This menu item is for technical personnel only, and is not displayed during the normal operation of the instrument. Please see section 4 above on how to access this menu item. Consult your local dealer or factory before entering this menu.



Move the highlight over the “DONE” menu item and press the rotary button to return to the main menu.

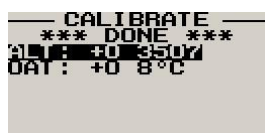

On the back of the ALT-3 you will find the calibration number that has been determined to ensure the most accurate reading of your altimeter. This is the value that should be entered here. Should you have access to an accurate reference you may use this function to calibrate your altimeter. Before you do this, ensure that your calibrated and certified reference is set to the local pressure of 1013mB (29.92”HG). Your altimeter has been calibrated by the factory to an accuracy of +/- one mB or approximately +/- 30 ft (10m).

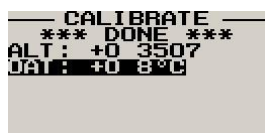

The ALT-3 is calibrated in degrees Celsius. The ALT-3 is calibrated at the factory using a precision laboratory thermometer. If recalibration is required then adjust the value using the up/down keys or the rotary control until the temperature matches the reference ambient temperature.

5 Loading factory default settings

Pressing and holding the F1 and F2 simultaneously on power up will cause the ALT-3 to load preprogrammed factory default settings. The following screen will be displayed:

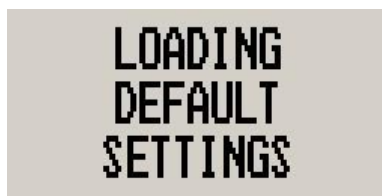

6 Operating the alarms

If the alarm is activated, the corresponding item on the display will flash. At the same time the externally available alarm switch will close. The switch will remain closed until any button is pressed to acknowledge the alarm or until the condition(s) that activated the alarm no longer exist. The alarm output can be used to switch an external alarm indicator. The external alarm switch is an open collector transistor switch to ground with a maximum rating of 0.5A DC. It is possible to wire the alarm contacts of several Stratomaster instruments in parallel should this be desired. To avoid false activation of the alarms, the alarm function is only active 10 seconds after the instrument has powered up.

7 Cleaning

The unit should not be cleaned with any abrasive substances. The screen is very sensitive to certain cleaning materials and should only be cleaned using a clean, damp cloth.

Warning: The ALT-3 is not waterproof, serious damage could occur if the unit is exposed to water and/or spray jets.

8 ALT-3 Specifications

Operating Temperature Range	-10°C to 50°C (14°F to 122°F)
Storage Temperature Range	-20°C to 80°C (-4°F to 176°F)
Humidity	<85% non-condensing
Power Supply	8 to 30Vdc SMPS (switch mode power supply) with built in 33V over voltage and reverse voltage protection
Current Consumption	Approx. 43mA @ 13.8V (backlight on) 16mA @13.8V (backlight off)
Display	128x64 graphic LCD display. Contrast and backlight is user configurable, green/yellow backlight
ADC	12bit over sampled successive approximation
Dimensions	see Velocity series dimensional drawing
Enclosure	3 1/8" ABS, black in color, front or rear mounting
Weight	Approx. 176 grams
Alarm contact current rating	Open collector transistor switch to ground. Maximum rating 0.5A DC
Non-volatile memory storage	100000 write cycles
Altimeter range	-1000ft to 30 000ft (-304m to 9144m)
Altimeter resolution	1ft/1m
Altitude measurement accuracy	+/- 1mB, +/- 30ft at sea level
Digital VSI range	+/-20ft/m to +/-10 000ft/m
Digital VSI resolution	10ft
Analog VSI range	+/-2000 ft/m, logarithmic scale
VSI measurement accuracy	+/- 2%, relative to calibration

9 Installation

Connect the static port to a suitable static air pressure line. If you have a slow aircraft or an aircraft where the internal cabin pressure does not change during flight and is equivalent to the outside air pressure you may find that it is not required to connect a static port.

For installations in typical ultralight aircraft pods, be aware of possible pressure changes inside the pod during flight caused by ram air or suction effects. This may lead to a false indication of altitude. Often these effects are dependent on the current angle of attack of the airflow around your pod. You will need to install a suitable static port in these cases.

The use of an external 1A fuse is recommended. Connect the supply terminals to your aircraft's power supply. The ALT-3 can be used on both 12V and 24V without the use of any pre-regulators. Ensure that the supply voltage will not drop below 8V during operation as this may result in incorrect readings.

9.1 ALT-3 DB9 Cable connections

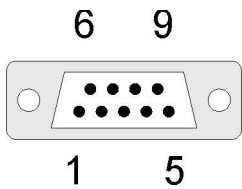

DB 9 Pin	Color	Function
1	Black	Ground
2	Orange	OAT Sensor
4	NC	Airtalk communication (Not connected). Used for firmware upgrading
6	Red	8-30Vdc power
9	White	Alarm Output

9.2 Connection Diagram

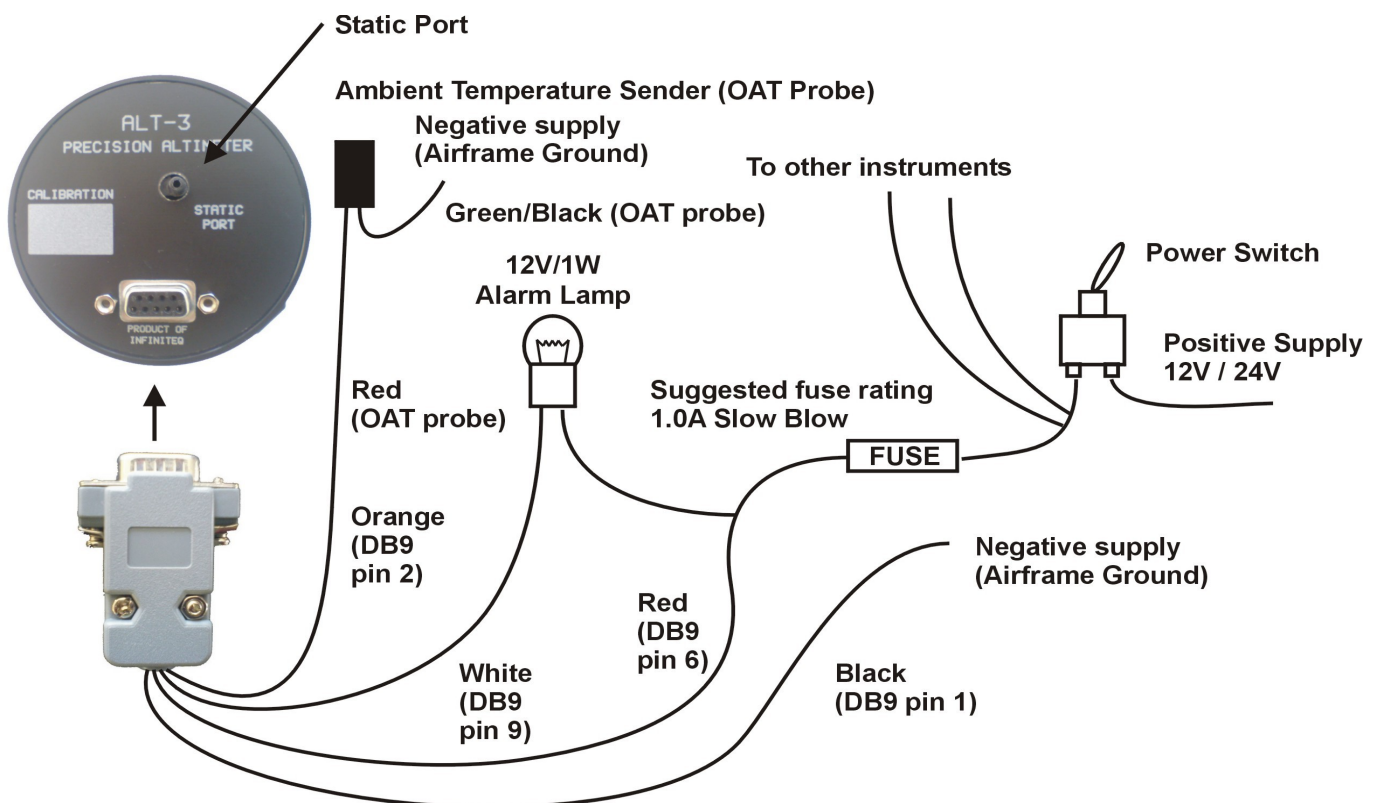

9.3 Pressure Port Dimensions

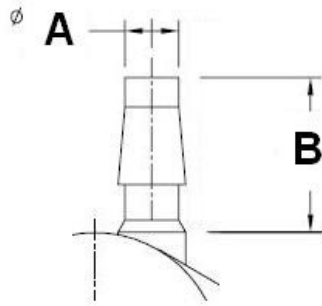

	Inches		Millimeters	
	Min	Max	Min	Max
A	0.182	0.194	4.62	4.93
B	0.420	0.440	10.67	11.18

10 Warranty

This product carries a warranty for a period of one year from date of purchase against faulty workmanship or defective materials, provided there is no evidence that the unit has been mishandled or misused. Warranty is limited to the replacement of faulty components and includes the cost of labor. Shipping costs are for the account of the purchaser.

Damage as a result of applying excessive pressure to the pressure ports are excluded from warranty.

Note: Product warranty excludes damages caused by unprotected, unsuitable or incorrectly wired electrical supplies and or sensors, and damage caused by inductive loads.

11 Disclaimer

Operation of this instrument is the sole responsibility of the purchaser of the unit. The user must make themselves familiar with the operation of this instrument and the effect of any possible failure or malfunction.

This instrument is not certified by the FAA. Fitting of this instrument to certified aircraft is subject to the rules and conditions pertaining to such in your country. Please check with your local aviation authorities if in doubt. This instrument is intended for ultralight, microlight, homebuilt and experimental aircraft. Operation of this instrument is the sole responsibility of the pilot in command (PIC) of the aircraft. This person must be proficient and carry a valid and relevant pilot's license. This person has to make themselves familiar with the operation of this instrument and the effect of any possible failure or malfunction. Under no circumstances does the manufacturer condone usage of this instrument for IFR flights.

The manufacturer reserves the right to alter any specification without notice.